



ErisTerminal® SIP DECT Base Station
and Cordless Handset

VSP600

VSP601

User Guide



Congratulations

on your purchase of this VTech product. Before using this product, please read **Important Safety Information** on page 4 of this manual. Please thoroughly read this user's manual for all the feature operations and troubleshooting information necessary to install and operate your product. You can also visit our website at **businessphones.vtech.com** or call **1 (888) 370-2006**.

Please note the serial number of your product, which can be found on the bottom of the base station. Save your sales receipt and original packaging in case it is necessary to return your telephone for warranty service.

Important Safety Information



This symbol is to alert you to important operating or servicing instructions that may appear on the product or in this user's manual. Always follow basic safety precautions when using this product to reduce the risk of injury, fire, or electric shock.

Important safety instructions

When using your telephone equipment, basic safety precautions should always be followed to reduce the risk of fire, electric shock and injury, including the following:

1. This product should be installed by a qualified technician.
2. This product should only be connected to the host equipment and never directly to the network such as Public Switch Telephone Network (PSTN) or Plain Old Telephone Services (POTS).
3. Read and understand all instructions.
4. Follow all warnings and instructions marked on the product.
5. Unplug this product from the wall outlet before cleaning. Do not use liquid or aerosol cleaners. Use a damp cloth for cleaning.
6. Do not use this product near water such as near a bath tub, wash bowl, kitchen sink, laundry tub or swimming pool, or in a wet basement or shower.
7. Do not place this product on an unstable table, shelf, stand or other unstable surfaces.
8. Slots and openings in the back or bottom of the base station and handset are provided for ventilation. To protect them from overheating, these openings must not be blocked by placing the product on a soft surface such as a bed, sofa or rug. This product should never be placed near or over a radiator or heat register. This product should not be placed in any area where proper ventilation is not provided.
9. This product should be operated only from the type of power source indicated on the marking label. If you are not sure of the type of power supplied at the premises, consult your dealer or local power company.
10. Do not allow anything to rest on the power cord. Do not install this product where the cord may be walked on.
11. Never push objects of any kind into this product through the slots in the base station or handset because they may touch dangerous voltage points or create a short circuit. Never spill liquid of any kind on the product.

12. To reduce the risk of electric shock, do not disassemble this product, but take it to an authorized service facility. Opening or removing parts of the base station or handset other than specified access doors may expose you to dangerous voltages or other risks. Incorrect reassembling can cause electric shock when the product is subsequently used.
13. Do not overload wall outlets and extension cords.
14. Unplug this product from the wall outlet and refer servicing to an authorized service facility under the following conditions:
 - A. When the power supply cord or plug is damaged or frayed.
 - B. If liquid has been spilled onto the product.
 - C. If the product has been exposed to rain or water.
 - D. If the product does not operate normally by following the operating instructions. Adjust only those controls that are covered by the operation instructions. Improper adjustment of other controls may result in damage and often requires extensive work by an authorized technician to restore the product to normal operation.
 - E. If the product has been dropped and the telephone base and/or handset has been damaged.
 - F. If the product exhibits a distinct change in performance.
15. Avoid using a telephone (other than cordless) during an electrical storm. There is a remote risk of electric shock from lightning.
16. Do not use the telephone to report a gas leak in the vicinity of the leak. Under certain circumstances, a spark may be created when the adapter is plugged into the power outlet, or when the handset is replaced in its cradle. This is a common event associated with the closing of any electrical circuit. The user should not plug the phone into a power outlet, and should not put a charged handset into the cradle, if the phone is located in an environment containing concentrations of flammable or flame-supporting gases, unless there is adequate ventilation. A spark in such an environment could create a fire or explosion. Such environments might include: medical use of oxygen without adequate ventilation; industrial gases (cleaning solvents; gasoline vapors; etc.); a leak of natural gas; etc.
17. Only put the handset of your telephone next to your ear when it is in normal talk mode.
18. The power adapters are intended to be correctly oriented in a vertical or floor mount position. The prongs are not designed to hold the plug in place if it is plugged into a ceiling, under-the-table or cabinet outlet.

19. Use only the power cord indicated in this manual.
20. For pluggable equipment, the socket-outlet shall be installed near the equipment and shall be easily accessible.
21. In wall mounting position, make sure to mount the telephone base on the wall by aligning the eyelets with the mounting studs of the wall plate. Then slide the telephone base down on both mounting studs until it locks into place. Refer to the full installation instructions in "Handset Installation" on page 16 in this User Guide.
22. CAUTION: Keep small metallic objects such as pins and staples away from the handset receiver.

SAVE THESE INSTRUCTIONS

Compliance

FCC part 15

This device complies with Part 15 of the FCC rules. Operation is subject to the following two conditions: (1) This device may not cause harmful interference, and (2) this device must accept any interference received, including interference that may cause undesired operation.

This equipment has been tested and found to comply with the limits for a Class A digital device, pursuant to Part 15 of the FCC Rules. These limits are designed to provide reasonable protection against harmful interference when the equipment is operated in a commercial environment. This equipment generates, uses, and can radiate radio frequency energy and, if not installed and used in accordance with the instruction manual, may cause harmful interference to radio communications. Operation of this equipment in a residential area is likely to cause harmful interference in which case the user will be required to correct the interference at the user's expense.

Privacy of communications may not be ensured when using this phone.

Warning: Changes or modifications to this equipment not expressly approved by the party responsible for compliance could void the user's authority to operate the equipment.

Caution: To maintain the compliance with the FCC's RF exposure guideline, place the base unit at least 20 cm from nearby persons.

For body-worn operation, this handset has been tested and meets the FCC RF exposure guidelines when used with the accessories supplied or designated for this product. Use of other accessories may not ensure compliance with FCC RF exposure guidelines.

This Class A digital apparatus complies with Canadian requirements:
CAN ICES-3 (A)/NMB-3(A).

Cet appareil numérique de la classe A est conforme à la norme CAN ICES-3 (A)/NMB-3(A) du Canada.

This device complies with Industry Canada license-exempt RSS standard(s).

Industry Canada

Operation is subject to the following two conditions: (1) this device may not cause harmful interference, and (2) this device must accept any interference received, including interference that may cause undesired operation of the device.

Privacy of communications may not be ensured when using this telephone.

The term "IC:" before the certification/registration number only signifies that the Industry Canada technical specifications were met.

This product meets the applicable Industry Canada technical specifications.

Eris Terminal SIP DECT Base Station and Cordless Handset VSP600 VSP601

Table of Contents

Important Safety Information 4

Important safety instructions..... 4

Introduction 10

About this guide..... 10

Product overview..... 10

Quick Reference Guide 11

Base station external features..... 11

Cordless handset external features.. 12

Dial pad and audio controls..... 12

Base Station Installation 13

Handset Installation 16

Installing the charger..... 16

Battery installation and charging..... 17

Wall mounting the charger..... 19

Adding a corded headset..... 20

Registering the handset to the base. 21

Deregistering the handset..... 22

Locating the Handset 23

Screen icons 23

Using the Handset 24

Idle screen..... 24

Making calls..... 24

Answering calls..... 25

Putting a call on hold..... 26

Switching between two calls..... 26

Transferring a call..... 27

Setting up a conference call..... 28

Listening to messages..... 29

Using the Directory..... 30

Using the Call History..... 32

Using Speed Dial..... 33

Configuring the Handset 34

Setting do not disturb..... 34

Setting call forwarding..... 34

Blocking anonymous calls..... 35

Dialing anonymously..... 35

Answering calls automatically..... 35

Setting missed-call alerts..... 36

Setting call waiting..... 36

Viewing handset status..... 36

Setting the language..... 37

Setting the date and time..... 37

Setting the handset name..... 37

Setting the screen brightness..... 37

Setting the ringer tone and volume... 38

Turning low battery tone on or off.... 38

Turning link lost tone on or off..... 38

Turning key tones on or off..... 38

Registering or deregistering your
handset..... 39

WebUI 40

Using the WebUI..... 40

System Status..... 42

Handset Status..... 43

Call Settings	43	Special characters	51
User Preferences.....	45	Entering special characters	51
Base Directory	46	Maintenance	52
Blacklist	48	Taking care of your telephone	52
Security.....	49	GPL License Information	53
Troubleshooting	50	GPL code requests	53
General issues.....	50		
Technical Specifications	51		

Introduction

About this guide

This user guide provides information about the external features of the base station and handset, installation and handset configuration instructions, and detailed instructions for using the handset. Please read this user's manual before using your handset.

Please refer to the *VSP600/VSP601 Administrator and Provisioning Manual* for complete configuration instructions. You can download the guide from **businessphones.vtech.com**.

For customer service or product information, visit our website at **businessphones.vtech.com** or call **1 (888) 370-2006**.

Product overview

The VTech VSP600 base station and VSP601 cordless handset is a full-featured SIP endpoint business phone system designed to work with popular hosted IP PBX services and on-premise SIP PBXs. Once you have ordered and configured your PBX service, the handset enables you to make and receive calls as you would with any other business phone. Up to six cordless handsets can be registered to the base station. Each handset provides calling features such as hold, transfer, conferencing, and speakerphone.

The VSP601 cordless handset features include:

- Orbitlink Wireless Technology™
- Backlit Liquid Crystal Display
- Speakerphone, Hold and Mute
- Up to 6 SIP lines/accounts
- Up to 4 concurrent calls across all handsets
- 3-way conferencing
- Corded headset support
- 200-entry local directory

Quick Reference Guide

Base station external features

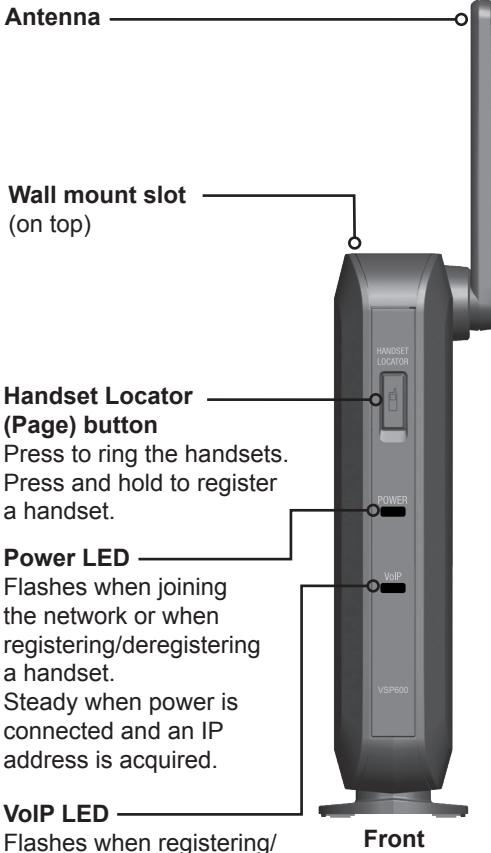

Handset Locator (Page) button
Press to ring the handsets.
Press and hold to register a handset.

Power LED
Flashes when joining the network or when registering/deregistering a handset.
Steady when power is connected and an IP address is acquired.

VoIP LED
Flashes when registering/deregistering a handset.
Steady when all SIP accounts are registered.
Off when a SIP account is not registered.

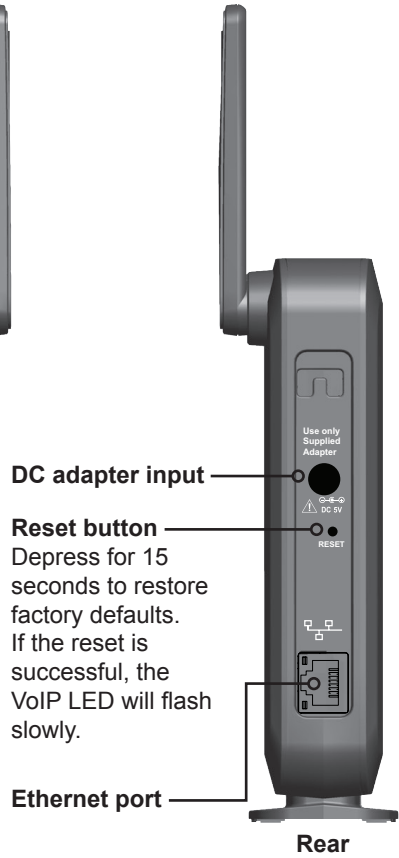

DC adapter input

Reset button
Depress for 15 seconds to restore factory defaults.
If the reset is successful, the VoIP LED will flash slowly.

Ethernet port

Quick Reference Guide

Cordless handset external features

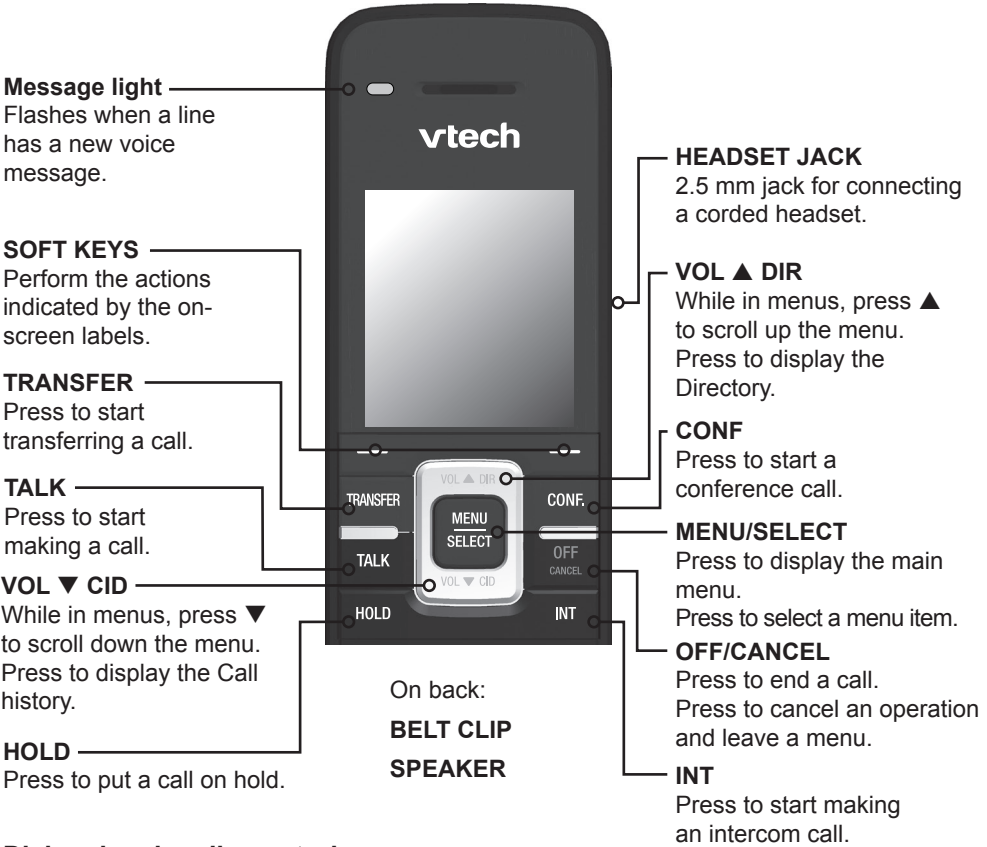

Dial pad and audio controls

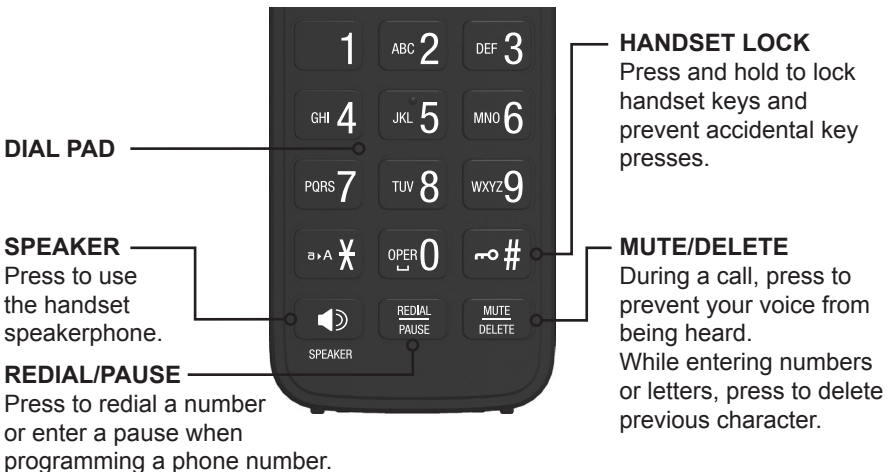

Base Station Installation

This section assumes that your network infrastructure is established and that your IP PBX phone service has been ordered and configured for your location. For more information about IP PBX configuration, see the *VSP600/VSP601 Administrator and Provisioning Manual*, available at

businessphones.vtech.com.

You can power the base station using a compatible VTech power adapter or using Power over Ethernet (PoE) from your network. (The base station requires PoE Class 2.) If you are not using PoE, install the base station near a power outlet not controlled by a wall switch. The base station can be placed on a flat surface or mounted on a wall in a vertical or horizontal orientation.

Avoid placing the base station too close to:

- Communication devices such as television sets, DVD players, or other cordless telephones
- Excessive heat sources
- Noise sources such as a window with traffic outside, motors, microwave ovens, refrigerators, or fluorescent lighting
- Excessive dust sources such as a workshop or garage
- Excessive moisture
- Extremely low temperature
- Mechanical vibration or shock such as on top of a washing machine or work bench

To install the base station:

1. Plug one end of the Ethernet cable into the Ethernet port on the rear of the base station (marked by ) , and plug the other end of the cable into your network router or switch.
2. If the base station is not using power from a PoE-capable network router or switch:
 - a. Connect a compatible VTech power adapter to the power jack.
 - a. Plug the power adapter into an electrical outlet that is not controlled by a wall switch.

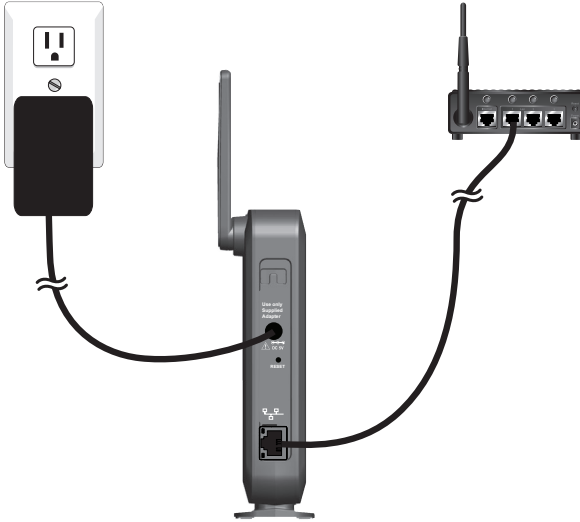

IMPORTANT INFORMATION

1. Use only a compatible VTech power adapter with this product. To order a power adapter, visit our website at businessphones.vtech.com or call **1 (888) 370-2006**.
2. The power adapter is intended to be correctly oriented in a vertical or floor mount position. The prongs are not designed to hold the plug in place if it is plugged into a ceiling, under-the-table or cabinet outlet.

To mount the base station on a wall:

1. Install two mounting screws on the wall. Choose screws with heads larger than 5 mm (3/16 inch) in diameter (1 cm / 7/16 inch diameter maximum). The screw centers should be 5 cm (1 15/16 inches) apart vertically or horizontally.
2. Tighten screws until only 3 mm (1/8 inch) of the screws are exposed.

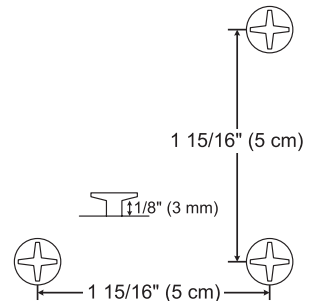

3. Attach the mounting plate to the top of the base station. Insert the tab into the slot and then push the plate in at the bottom of the base station until the mounting plate clicks into place.



4. Check to make sure the plate is secure at top and bottom. It should be flush with the base station body.
5. Place the base station over the mounting screws.

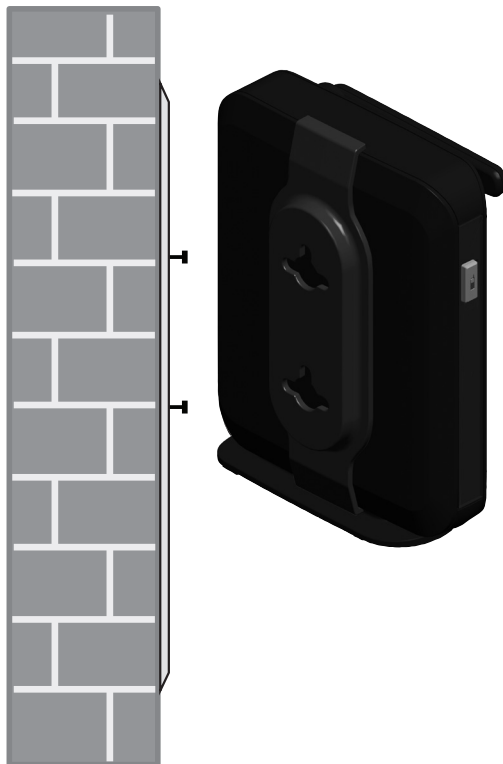

6. Connect power and the Ethernet cable as described in "To install the base station."

Handset Installation

This section assumes that your network infrastructure is established and that your IP PBX phone service has been ordered and configured for your location.

Handset installation involves both the handset and the handset charger. The charger is powered using the supplied power adapter. The charger can be placed on a flat surface or mounted on a wall.

Avoid placing the handset and charger too close to:

- Communication devices such as television sets, DVD players, or other cordless telephones
- Excessive heat sources
- Noise sources such as a window with traffic outside, motors, microwave ovens, refrigerators, or fluorescent lighting
- Excessive dust sources such as a workshop or garage
- Excessive moisture
- Extremely low temperature
- Mechanical vibration or shock such as on top of a washing machine or work bench

Installing the charger

Install the charger as shown below.

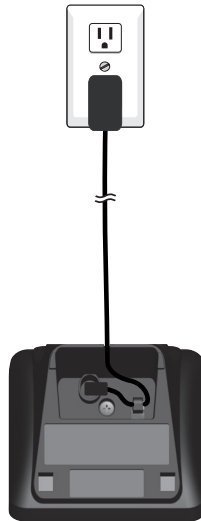

Plug the power adapter into an electrical outlet not controlled by a wall switch.



IMPORTANT INFORMATION

1. Use only the power adapter supplied with this product. To order a replacement power adapter, visit our website at **businessphones.vtech.com** or call **1 (888) 370-2006**.
2. The power adapter is intended to be correctly oriented in a vertical or floor mount position. The prongs are not designed to hold the plug in place if it is plugged into a ceiling, under-the-table or cabinet outlet.

Battery installation and charging

Install the battery as shown on the following page. Once you have installed the battery, the screen indicates the battery status (see the table below). If necessary, place the handset in the charger to charge the battery. For best performance, keep the handset in the charger when not in use. The battery is fully charged after 11 hours of continuous charging.

If the screen is blank, you need to charge the handset without interruption for at least 30 minutes to give the handset enough charge to use the telephone for a short time. When the battery is low, the handset shows **Low battery** and a flashing .

Battery indicators	Battery Status	Action
The screen is blank or shows Place in charger and  flashes.	The battery has no or little charge. The handset cannot be used.	Charge without interruption (at least 30 minutes).
The screen shows Low battery and  flashes.	Battery has enough charge to be used for a short time.	Charge without interruption (at least 30 minutes).
Full battery icon () appears.	Battery is charged.	To keep the battery charged, place it in the charger when not in use.

To install the handset battery:

1. Plug the battery connector securely into the socket inside the handset battery compartment. Insert the supplied battery with the label THIS SIDE UP facing up as indicated.
2. Align the cover flat against the battery compartment, then slide it upwards until it clicks into place.



3. Charge the handset by placing it face forward in the charger. The battery icon indicates the charge status as the battery charges.

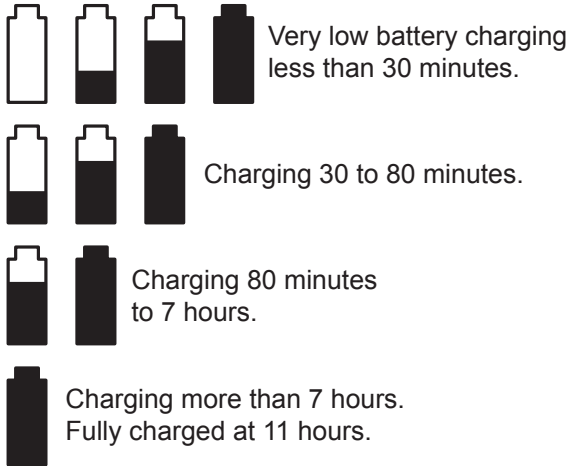

IMPORTANT INFORMATION

- Use only the supplied rechargeable battery or replacement battery (model BT164392). To order a replacement battery, visit our website at **businessphones.vtech.com** or call **1 (888) 370-2006**.
- If you do not use the handset for a long time, disconnect and remove the battery to prevent possible leakage.

Wall mounting the charger

The charger is ready for tabletop use. If you want to mount the charger on a wall, use two 10 mm (7/16 inch) screws and wall anchors (not provided) to hold the charger in place. Screws and wall anchors are not provided, but are available for purchase at hardware retailers. You might need a professional to install the charger.

To mount the charger on the wall:

1. Use a pencil to mark the desired positions of the two holes on the wall. Make sure the space between the two holes is 30 mm. Drill two holes in the wall according to the marks.

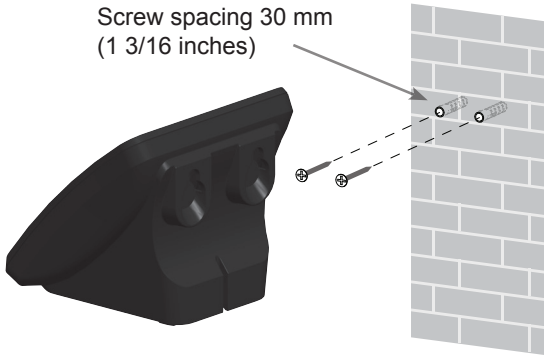

2. If you drill the holes into a stud, go to step 3.

-OR-

If you drill the holes into an object other than a stud, insert the wall anchors (not provided) into the holes and tap gently on the ends with a hammer until the wall anchors are flush with the wall.

3. Insert the screws (not provided) into the holes and tighten them until only 1/4 inch of the screws are exposed.
4. Align the holes at the back of the charger with the screws on the wall and slide the charger down until it locks into place.



Adding a corded headset

You can use this handset hands-free when you install any industry-standard 2.5 mm corded telephone headset (purchased separately).

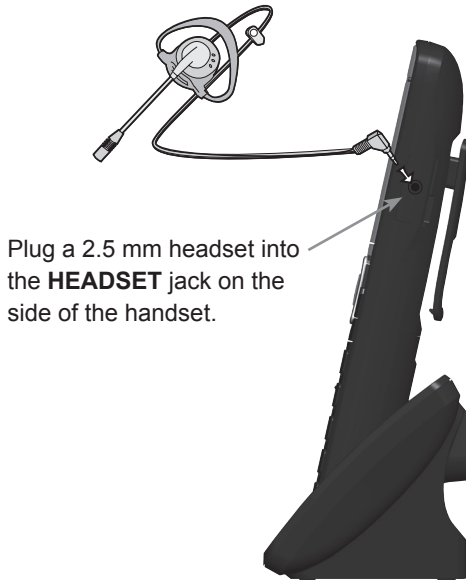

Registering the handset to the base

The handset must be registered to the base station in order to make and receive calls.

To register the handset:

1. Make sure the handset has a charged battery before proceeding. Make sure the base station is connected to power.
2. Press **MENU** on the handset. The Main Menu appears.
3. Press ▼ to scroll to **User settings** and press **SELECT**.
4. Press ▼ to scroll to **Registration** and press **SELECT**.
5. With **Handset** highlighted, press **SELECT**. The handset screen displays instructions. Press **NEXT** to continue reading the instructions.
6. On the base station, press the **HANDSET LOCATOR** button for at least four seconds, then release the button. Both LEDs on the base station begin to flash.
7. Press the **#** key on the handset to begin registration. The process takes up to 10 seconds to complete. When the first handset registers, it beeps and the screen displays **HANDSET 1**.

If the handset fails to register, place it in the charger again for a few seconds, remove it and repeat the registration procedure.

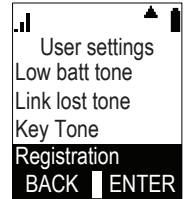
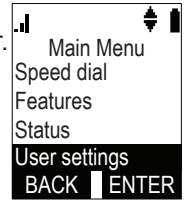

Deregistering the handset

Before using the handset with a different base station, you must deregister the handset from the base station to which it is currently registered.

To deregister the handset:

1. Press **MENU** on the handset. The Main Menu appears.
2. Press **▼** to scroll to **User settings** and press **SELECT**.
3. Press **▼** to scroll to **Registration** and press **SELECT**.
4. Press **▼** to highlight **Deregistration** and press **SELECT**.
The handset screen displays a list of registered handsets.
5. Highlight the name of the handset you want to deregister, and then press **SELECT**.
6. On the base station, press the **HANDSET LOCATOR** button for at least four seconds, then release the button. Both LEDs on the base station begin to flash.
7. On the handset, enter the System PIN and then press **SELECT** to begin deregistration. The default PIN is 1592.

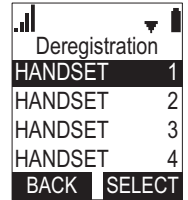
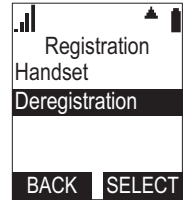

The deregistration process takes up to 10 seconds to complete. When the handset deregisters, it beeps and the screen displays **Unregistered**.

Note: The handset enters an energy-saving charging mode after being deregistered. All cordless telephone functions except handset-battery charging are disabled. Energy-saving charging mode is deactivated after the handset registers to the base station.

Locating the Handset

You can find handsets by paging them from the base. Press the **HANDSET LOCATOR** (page) button on the base station to ring all handsets:



- All handsets within range of the base will ring for one minute, even if the volume is off.
- To end the locator page, press **STOP** or place the handset in its charger.
- To silence the locator page on one handset only, press **SILENCE**.

Screen icons

The following screen icons indicate your phone's current status:

Icon	Status
	Indicates signal strength, from one bar (weak) to four bars (strong). Flashes when out of range.
	Indicates battery strength from 1/3 to 3/3. Flashes when empty.
	The ringer is off.
	Headset—audio is coming through a headset after the HEADSET key was pressed.
	Speakerphone—the speakerphone is active.
	Microphone is muted.
	Call Forward All is on.
	Do Not Disturb is on.

Using the Handset

This section describes how to use the handset to make calls and answer calls. This section also describes how to put calls on hold, transfer calls, and create conference calls.

Idle screen

The Idle screen appears after the phone is connected and configured for your SIP PBX service. The Idle screen indicates that you have no active or held calls.

From the Idle screen, you can press:

- **LINE** to select another line (SIP Account). When you make a call, the phone will use this line. See “Making calls” on page 24. **Note:** **LINE** appears only if more than one SIP account is registered to your phone.
- **MENU** to view the main menu. See “Configuring the Handset” on page 34.

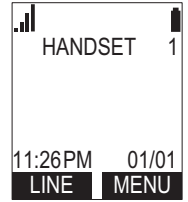

Making calls

You can make calls to any phone number (an outside call), or you can call another handset (an internal call).

To make an outside call:

1. Use the dial pad to enter the desired number.
 - Press **BACKSP** if you enter an incorrect digit.
2. If you wish to choose an outgoing line for the call:
 - a. Press **LINE**.
 - a. Press **▼** or **▲** to select the dialing line.
 - a. Press **SELECT**.
3. Dial the number by pressing **TALK** or **SPEAKER**.

When the call is answered, the active call screen appears.



4. To hang up the call, press **OFF** or **END**.

Note that you can also live dial a number by pressing **TALK** or **SPEAKER** to go off hook before entering a phone number. The call will dial automatically when a valid number is entered, or you can press **DIAL** to call the number immediately.

To make an internal call:

1. Press **INT**.
2. Press **▲** or **▼** to select the handset you wish to call, then press **SELECT** .
When the call is answered, the active call screen appears.

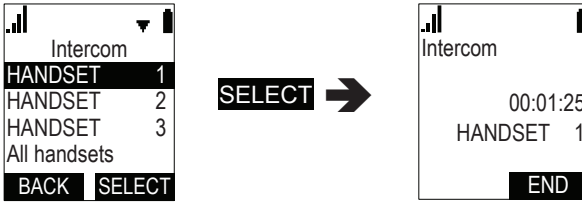

3. To hang up the call, press **OFF** or **END** .

Answering calls

You can answer a call by pressing **TALK**, **SPEAKER**, or **ANSWER** :



- For incoming calls from an outside number, you can also press **REJECT** to terminate the call.
- If you have multiple incoming calls, (as indicated by ) , press **▼** or **▲** to select the call you want to answer.
- Internal calls from another handset cannot be rejected, but they can be silenced by pressing **SILENCE** :

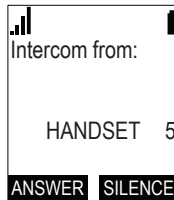

If you don't respond to an incoming outside call, the phone displays a missed-call alert on the idle screen:

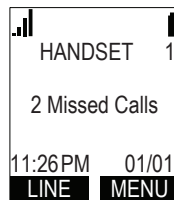

Putting a call on hold

You can put an outside call on hold by pressing **HOLD**. The handset also puts calls on hold automatically when you answer another call, transfer a call, or create a conference. Note that you cannot put an internal call on hold.

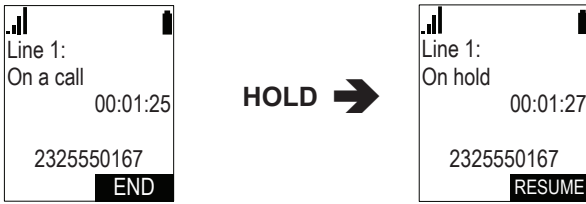

From the On Hold screen, you can press **RESUME** to take the call off hold.

If another party puts you on hold, you may see the message **Held by far end**. This message depends on compatibility between phones and PBX types, and may not always appear. You can press **END** to end the call.

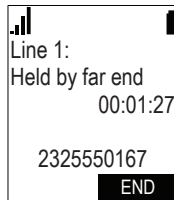

To make a new call while on hold:

1. When you have a call on hold, press the **MENU** key.
2. With **New call** highlighted, press **ENTER**.



3. Enter the number you wish to dial.

Switching between two calls

If you are managing two calls, switch between them by pressing **NEXT**:

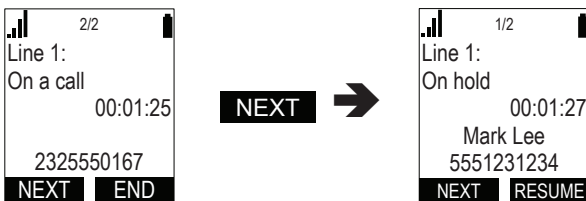

Transferring a call

You can transfer a call to another party.

If you talk to the transfer recipient before completing the transfer, you are making a “supervised” transfer.

However, the transfer recipient does not have to talk to you before receiving the transferred call. If you do not talk to the transfer recipient before transferring the call, you are making a “blind” transfer.

You can also transfer a call to a held call. Note that you cannot transfer internal calls.

To transfer a call (supervised):

1. During a call, press **TRANSFER**. The call is automatically put on hold and the transfer setup screen appears.



2. If you wish to transfer to an outside number, select **A new party**. Or if you wish to transfer to another handset in your system, select **A handset party**.
3. Press **SELECT**.
4. Dial the number to which you want to transfer the call, or select the handset to transfer to. You can also use a number from a list, such as the Directory or Call History.
5. When the second caller answers, you can talk to the caller to notify them of the transfer, then press **TRANS.** to transfer the call.

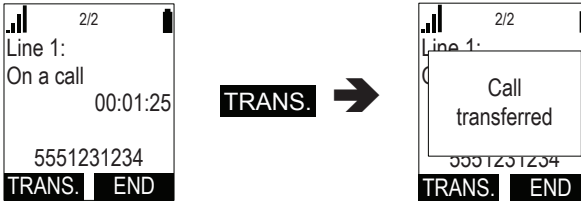

To transfer a call (blind):

1. During a call, press **TRANSFER**. The call is automatically put on hold and the transfer setup screen appears.
2. Select **A new party**, then press **SELECT**.



SELECT →

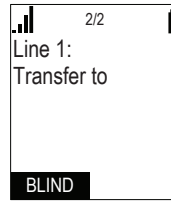

3. Press **BLIND**.
4. Dial the number to which you want to transfer the call. You can also use a number from a list, such as the Directory or Call History.
5. Wait for the phone to automatically dial, once it recognizes a valid number.
6. When the far end picks up, the call will be immediately transferred.

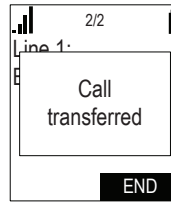
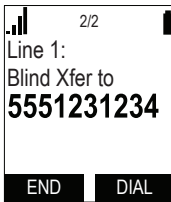

To transfer a call to a held call:

1. If you are on an active call and also have a call on hold, press **TRANSFER**. A list of held calls will appear.

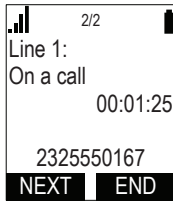

TRANSFER →

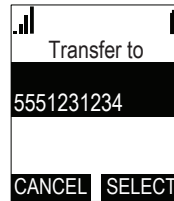

2. With the call you want to transfer to highlighted, press **SELECT**. The call will be immediately transferred.

Setting up a conference call

You can hold a conference call between yourself and two other parties.

To set up a conference call:

1. During a call, press **CONF**. The call is automatically put on hold and the conference setup screen appears.

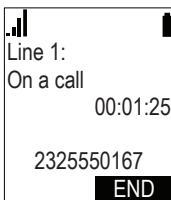

CONF. →



2. If you wish to conference with an outside number, select **A new party**. Or

if you wish to conference with another handset in your system, select **A handset party**.

3. Press **SELECT**.
4. Dial the second number for the other party you want to join your conference, or select the handset to conference with. You can also use a number from a list, such as the Directory or Call History.
5. When the second call is established, press **CONF.** . The conference begins and the conference screen appears.

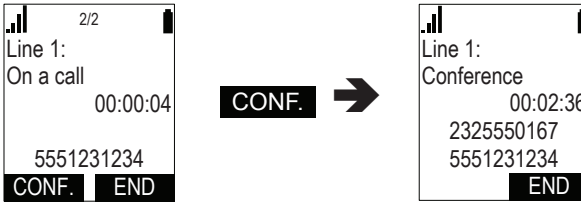

Press **END** to terminate both calls and end the conference.

To create a conference with a held call:

1. If you are on an Active call and also have a call on hold, press **CONF.** A list of held calls will appear.



2. With the call you want to conference with highlighted, press **SELECT** . The conference will begin immediately.

Setting up a Network Conference:

A Network Conference is hosted by your service provider and allows multiple parties to join a conference. A Network Conference works in a similar way to the regular conference described above, except you can add as many parties as your service provider supports. Pressing the **CONF.** key or the **Add** soft key during a conference will allow you to add more parties to the ongoing conference.

Listening to messages

When you have new messages, the phone displays a new-messages notification on the idle screen:

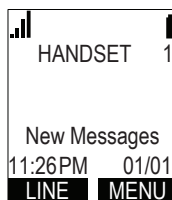

To listen to your messages:

1. From the handset Main Menu, with **Message** highlighted, press **SELECT**.
The Message screen appears. A message icon (✉) appears at the top of the screen for any line that has a message.



2. Press ▼ to highlight the desired line and press **SELECT**.
The handset dials the voicemail access number.
3. Follow the voice prompts to listen to your messages.

Using the Directory

The handset has three lists of contacts. The **Local directory** is only available on your handset. The **Base directory** is usually maintained by your system administrator, and is available on all handsets. The **Blacklist** contains blocked numbers.

To view a directory:

1. From the handset Main Menu, press ▼ to scroll to **Directory** and press **SELECT**, or press ▲ when the phone is idle.
The Directory menu appears.
2. Press ▲ or ▼ to select the directory you wish to view, then press **REVIEW**.
3. Press ▼ or ▲ to browse through contacts.



To call a contact:

When viewing a directory entry, you can call a contact in the following ways.

1. Dial the phone number in the entry:
 - a. Press **TYPE** to cycle through work, mobile, and other numbers.
 - b. Press **DIAL** to call the contact.
2. Revise the phone number to dial before calling:
 - a. Press **MENU**.
 - b. Press ▼ to scroll to **Edit dial** and press **SELECT**.
 - c. Edit the number as required, then press **DIAL**.

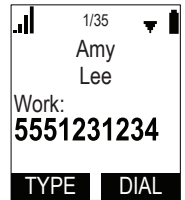

To search a directory:

1. From the handset Main Menu, press ▼ to scroll to **Directory** and press **SELECT**.
The Directory menu appears.



2. Press ▲ or ▼ to select the directory to search, then press **OPTION** .
3. With **Search** highlighted, press **SELECT**.
4. Enter a name or number, then press **SEARCH** .

To add a new entry:

1. From the handset Main Menu, press ▼ to scroll to **Directory** and press **SELECT**.

The Directory menu appears.

2. Press ▲ or ▼ to select the directory to add a new entry to, then press **OPTION** .
3. Press ▼ to scroll to **Add new** and press **SELECT**.
4. You can add a first name and last name, as well as work, mobile, and other phone numbers. You can also set the ringer tone and dial line for the entry.
5. When you are done, press **SAVE** .



To edit an entry:

1. When viewing the directory entry you wish to edit, press **MENU**.
2. With **Edit** highlighted, press **SELECT**.
3. When you are done editing, press **SAVE** .

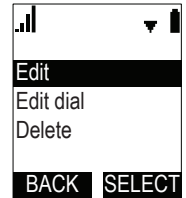

To delete an entry:

1. When viewing the directory entry you wish to delete, press **MENU**.
2. Press ▼ to scroll to **Delete** and press **SELECT**.
3. Press **YES** on the delete confirmation screen.

To delete all entries:

1. From the handset Main Menu, press ▼ to scroll to **Directory** and press **SELECT**.
The Directory menu appears.
2. Press ▲ or ▼ to select the directory to delete, then press **OPTION** .
3. Press ▼ to scroll to **Delete all** and press **SELECT**.
4. Press **YES** on the delete all confirmation screen.



Using the Call History

The Call History contains lists of your missed, received, and dialed calls (you can also view dialed calls by pressing **REDIAL**). You can view, call and store list entries.

To view the Call History:

1. From the handset Main Menu, press ▼ to scroll to **Call History** and press **SELECT**, or press ▼ when the phone is idle.

The Call History menu appears.

2. Press ▼ to highlight the desired list and press **SELECT**.
3. Press ▼ or ▲ to view entries.



The Call History entry screen shows the time, date, name and number of the call, the number of entries in the folder, along with an icon indicating the type of call.



To call an entry:

When viewing a Call History entry, you can call the entry in the following ways.

1. Press **DIAL** to call the phone number in the entry.
2. Revise the phone number to dial before calling:
 - a. Press **MENU**.
 - b. With **Edit dial** highlighted, press **SELECT**.
 - c. Edit the number as required, then press **DIAL**.



To save an entry to a directory:

1. Press **MENU** when viewing a Call History entry.
2. Press ▼ to scroll to **Save** and press **SELECT**.
3. Press ▲ or ▼ to select the directory to save to, then press **ENTER**.
4. Edit the new directory entry as required, then press **SAVE** to return to Call History.

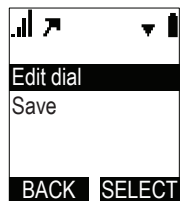

To delete entries:

1. To delete the entry you are viewing, press **DELETE**.
2. To delete all entries:
 - a. In the main Call History menu, press ▲ or ▼ to scroll to the list you wish to delete.
 - b. Press **DEL ALL**.
 - c. Press **YES** on the delete all confirmation screen.



Using Speed Dial

The speed dial feature allows you to program up to 10 numbers that you dial frequently. To dial a speed dial number, press and hold the dial pad key that matches the speed dial entry number (for entry 10, press and hold **0**).

To program a Speed Dial number:

1. Press **MENU**.
2. Press **▼** to scroll to **Speed dial** and press **SELECT**.
3. Press **▼** or **▲** to select an empty slot, then press **ADD** .

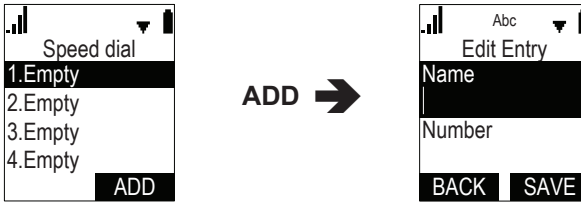

4. Use the dial pad to enter a name and number, then press **SAVE** .

To delete or edit existing Speed Dial entries, select the entry in the Speed Dial list then press **DELETE** or **EDIT** .

Configuring the Handset

You can configure the phone using one of two methods:

1. The **Features** and **User settings** menus on the phone.
2. The WebUI, which you access using your Internet browser.

This section describes settings you can change using your handset. For information about settings you can change on the WebUI, see “WebUI” on page 40.

The system administrator can configure additional settings, including Network settings, Provisioning, and the PIN code by using the **Admin settings** menu. For more information about this menu, see the *VSP600/VSP601 Administrator and Provisioning Manual*, available at

businessphones.vtech.com.

Setting do not disturb

When Do Not Disturb (DND) is on for a line, calls to that line will be rejected.

To turn DND on or off:

1. Press **MENU**.
2. Press ▼ to scroll to **Features** and press **SELECT**.
3. With **DND** highlighted, press **SELECT**.
4. Press ▲ or ▼ to select which line DND should apply to*, then press **SELECT** to turn it on or off.
5. Press **SET** to save.

* Note that DND will apply to all handsets assigned the line.

Setting call forwarding

Calls can be forwarded to another phone number always, only when busy, or after a set number of rings.

To set call forward:

1. Press **MENU**.
2. Press ▼ to scroll to **Features** and press **SELECT**.
3. Press ▼ to scroll to **Call forward** and press **SELECT**.
4. Press ▲ or ▼ to select which line Call forward should apply to*, then press **SELECT**.
5. Press ▼ to highlight the desired option:
 - Always
 - Busy
 - No answer
6. Press **SELECT**.

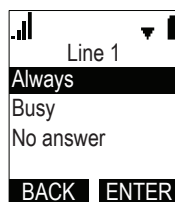
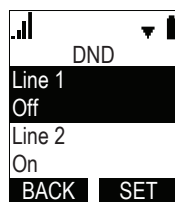
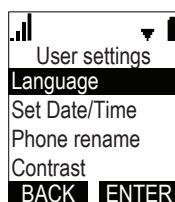
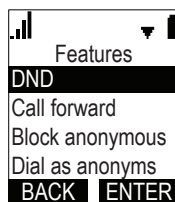

7. On the next screen, press **SELECT** to turn call forwarding On or Off.
8. Press ▼.
9. Enter the number to which you would like to forward calls.
10. (If you selected **No answer** earlier) Press ▼.
11. (If you selected **No answer** earlier) Press **SELECT** to set the No answer delay between 1 to 10 rings.
12. Press **SET**.



When Call forward is on, **FWD** appears on the idle screen.

* Note that Call forward will apply to all handsets assigned the line.

Blocking anonymous calls

Calls without Caller ID information will be rejected and the handset will not ring.

To block anonymous callers:

1. Press **MENU**.
2. Press ▼ to scroll to **Features** and press **SELECT**.
3. Press ▼ to scroll to **Block anonymous** and press **SELECT**.
4. Press ▲ or ▼ to select which line Block anonymous should apply to*, then press **SELECT** to turn it on or off.
5. Press **SET** to save.

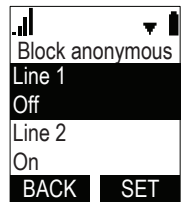

* Note that Block anonymous will apply to all handsets assigned the line.

Dialing anonymously

When this feature is enabled, your phone will make anonymous outgoing calls.

To dial as an anonymous caller:

1. Press **MENU**.
2. Press ▼ to scroll to **Features** and press **SELECT**.
3. Press ▼ to scroll to **Dial as anonyms** and press **SELECT**.
4. Press ▲ or ▼ to select which line Dial as anonymous should apply to*, then press **SELECT** to turn it on or off.
5. Press **SET** to save.

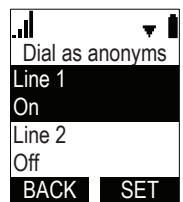

* Note that Dial as anonymous will apply to all handsets assigned the line.

Answering calls automatically

When this feature is enabled, lifting the handset out of the charger will automatically answer an incoming call.

To answer calls when lifting the handset:

1. Press **MENU**.
2. Press ▼ to scroll to **Features** and press **SELECT**.

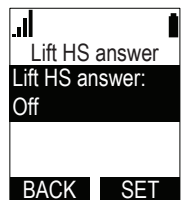

3. Press ▼ to scroll to **Lift HS answer** and press **SELECT**.
4. Press **SELECT** to select either On or Off.
5. Press **SET** to save.

Setting missed-call alerts

When missed-call alerts are enabled, an alert will display on the idle screen whenever you do not answer an incoming call.

To turn missed-call alerts on or off:

1. Press **MENU**.
2. Press ▼ to scroll to **Features** and press **SELECT**.
3. Press ▼ to scroll to **Miss call alert** and press **SELECT**.
4. Press ▲ or ▼ to highlight **Show alert** or **Hide alert**.
5. Press **SET**.



Setting call waiting

When call-waiting alerts are enabled, an alert will display on-screen whenever you receive an incoming call during an active call.

To turn call-waiting alerts on or off:

1. Press **MENU**.
2. Press ▼ to scroll to **Features** and press **SELECT**.
3. Press ▼ to scroll to **Call waiting** and press **SELECT**.
4. Press ▲ or ▼ to highlight **Show alert** or **Hide alert**.
5. Press **SET**.



Viewing handset status

In the Status menu, you can view information on the LAN network your phone system is connected to, the registration status of your SIP accounts, or view the software version of your handset. You may need this information for troubleshooting purposes.

To view the Status menu:

1. Press **MENU**.
2. Press ▼ to scroll to **Status** and press **SELECT**.
3. Press ▼ to scroll to either **Network**, **Line**, or **Product Info**, and press **SELECT**.

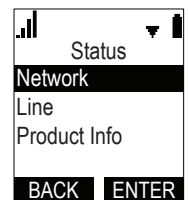

To view the software version of your phone:

1. From the **Status** menu, select **Product Info** and press **SELECT**.
2. With **Handset** highlighted, press **SELECT**.
3. Scroll down to view the software version.

Setting the language

1. Press **MENU**.
2. Press ▼ to scroll to **User settings** and press **SELECT**.
3. With **Language** highlighted, press **SELECT**.
4. Press ▲ or ▼ to highlight the desired language.
5. Press **SET** to save.



Setting the date and time

1. Press **MENU**.
2. Press ▼ to scroll to **User settings** and press **SELECT**.
3. Press ▼ to scroll to **Set Date/Time** and press **SELECT**.
4. To set the date, highlight **Set date**, then use the dial pad to enter the date.
5. To set the time, highlight **Set time**, then use the dial pad to enter the time.
6. Press **SET**.

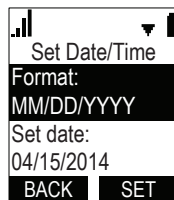

Setting the handset name

You can change the handset name from the default HANDSET.

To change the handset name:

1. Press **MENU**.
2. Press ▼ to scroll to **User settings** and press **SELECT**.
3. Press ▼ to scroll to **Phone rename** and press **SELECT**.
4. Press **BACKSP** to move the cursor back and delete the previous name.
5. Enter the new name using the dial pad.
6. Press **SET** when complete.



Setting the screen brightness

You can change the brightness of text and graphics on the handset LCD.

To change the LCD brightness:

1. Press **MENU**.
2. Press ▼ to scroll to **User settings** and press **SELECT**.
3. Press ▼ to scroll to **Contrast** and press **SELECT**.
4. Press ▼ or ▲ to select a brightness level between 1 and 8.
5. Press **SET**.

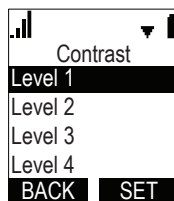

Setting the ringer tone and volume

1. Press **MENU**.
2. Press ▼ to scroll to **User settings** and press **SELECT**.
3. Press ▼ to scroll to **Ringers** and press **SELECT**.
4. To change the ringer volume:
 - a. Highlight **Ringer Volume** and press **SELECT**.
 - b. Press ▼ or ▲ to change the volume level as desired.
 - c. Press **SET** to save.
5. To change the ringer tone:
 - a. Highlight **Ringer Tone** and press **SELECT**.
 - b. Press ▼ or ▲ to select a line, then press **ENTER**.
 - c. Press ▼ or ▲ to select a ringer tone.
 - d. Press **SET** to save.

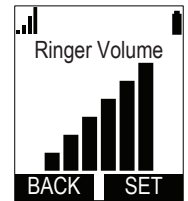
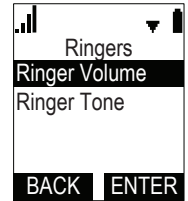

Turning low battery tone on or off

1. Press **MENU**.
2. Press ▼ to scroll to **User settings** and press **SELECT**.
3. Press ▼ to scroll to **Low batt tone** and press **SELECT**.
4. Press **SELECT** to turn the low battery tone on or off.
5. Press **SET** to save.

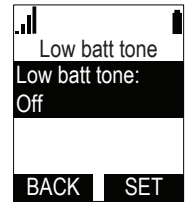

Turning link lost tone on or off

1. Press **MENU**.
2. Press ▼ to scroll to **User settings** and press **SELECT**.
3. Press ▼ to scroll to **Link lost tone** and press **SELECT**.
4. Press **SELECT** to turn the link lost tone on or off.
5. Press **SET** to save.

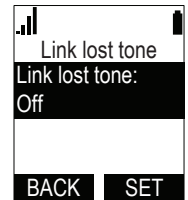

Turning key tones on or off

1. Press **MENU**.
2. Press ▼ to scroll to **User settings** and press **SELECT**.
3. Press ▼ to scroll to **Key Tone** and press **SELECT**.
4. Press **SELECT** to turn key tones on or off.
5. Press **SET** to save.

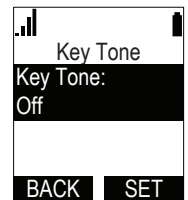

Registering or deregistering your handset

You can register or deregister your handset using the handset menu. Follow the instructions in “Registering the handset to the base” on page 21 and “Deregistering the handset” on page 22.

WebUI

Using the WebUI

Use an Internet browser to access the Web User Interface (WebUI) that resides on your base station. After you log on to the WebUI, you can configure the following features:

- Call Settings
- User Preferences
- Base Directory
- Blacklist
- User Password

The WebUI also has a System Status and Handset Status page, where you can view network status and registration information about your handset.

To access the WebUI:

1. Ensure that your computer is connected to the same network as your base station.
2. Find the IP address of your base station:
 - a. When the phone is idle, press **MENU**.
 - b. Press **▼** to highlight **Status**, and then press **SELECT**. The Status menu appears:

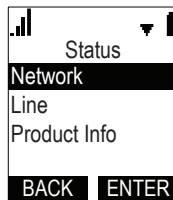

- c. On the Status menu, ensure that **Network** is highlighted, and then press **SELECT**. The Network screen appears:

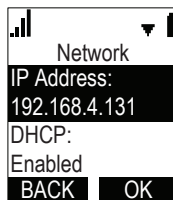

- d. On the Network screen, note the IP Address.
3. On your computer, open an Internet browser. Depending on your browser, some of the pages presented here may look different and have different controls.

4. Type the phone IP address in the browser address bar and press **ENTER** on your computer keyboard:



A Login window appears.

5. Under **User Name**, enter **user**.
6. Under **Password**, enter **user**, or your own password, if you have created one. You can create or change a password after you log on.
7. Click **Log In / OK**. The WebUI appears.

Click topics from the navigation bar at the top of the page, and then click the desired setting on the left side of the WebUI to see the page for that setting. You view and change settings in two different types of fields: drop-down lists and entry fields into which you type information. For your security, the WebUI times out after 10 minutes, so if it is idle for that time, you must log on again.

The remaining procedures in this section assume that you have already logged on to the WebUI.

System Status

The System Status page shows:

- **General** information about your phone, including model, MAC address, and firmware version.
- **Account Status** information about your SIP account registration.
- **Network** information regarding your phone's network address and network connection.

The System Status page has no settings that you can change. You may need some of the status information for troubleshooting purposes.

STATUS	STATUS	SYSTEM	CONTACTS	SERVICING
System Status				
Handset Status				
General				
		Model:	VSP600	
		Serial Number:	UK900001923	
		MAC Address:	00:12:2A:46:15:88	
		Boot Version:	1.04	
		Firmware Version:	0.68.0.27243-ENG	
		V-Series:	0.68.0.27243-ENG	
		Hardware Version:		
Account Status:				
		Account 1:	Registered	
		Account 2:	Registered	
		Account 3:	Registered	
		Account 4:	Not Registered	
		Account 5:	Not Registered	
		Account 6:	Not Registered	
Network				
		LAN Port IP Address:	10.88.51.189	
		IP type:	DHCP	
		Subnet Mask:	255.255.0.0	
		MAC Address:	00:12:2A:46:15:88	
		Link Status:	Connected	
		Gateway:	10.88.3.149	
		Primary DNS:	10.88.162.31	
		Secondary DNS:	10.88.162.10	
		Network Time Settings	us.pool.ntp.org	

Handset Status

The Handset Status page shows registration information for your handsets.

STATUS

System Status

Handset Status

	STATUS	SYSTEM	CONTACTS	SERVICING
Handset Status				
		Name	Registration Status	
1:		HANSET	Registered	
2:		HANSET	Not Registered	
3:		HANSET	Not Registered	
4:		HANSET	Not Registered	
5:		HANSET	Not Registered	
6:		HANSET	Not Registered	

The Handset Status page has no settings that you can change. You may need some of the status information for troubleshooting purposes.

Call Settings

To view the call settings, click **SYSTEM** in the WebUI header, and then click **Call Settings** in the sidebar. You can configure call settings for each account that is available to your phone. Click **Account 1**, **Account 2**, and so on to select the call settings page for the desired account.

Call Settings include Do Not Disturb and Call Forward settings. You can also set Do Not Disturb and Call Forward using the handset. See “Configuring the Handset” on page 34.

When you have finished changing settings on this page, click **Save** to save them.

SYSTEM

Call Settings

Account 1

Account 2

Account 3

Account 4

Account 5

Account 6

User Preferences

	STATUS	SYSTEM	CONTACTS	SERVICING
SYSTEM CALL SETTINGS 1				
General Call Settings				
		<input type="checkbox"/> Anonymous Call Reject		
		<input type="checkbox"/> Enable Anonymous Call		
Do Not Disturb				
		<input type="checkbox"/> Enable DND		
Call Forward				
		<input type="checkbox"/> Enable Call Forward Always		
	Target Number:		<input type="text"/>	
		<input type="checkbox"/> Enable Call Forward Busy		
	Target Number:		<input type="text"/>	
		<input type="checkbox"/> Enable Call Forward No Answer		
	Target Number:		<input type="text"/>	
	Delay:		6 rings	<input type="text"/>
		<input type="button" value="Save"/>		

General Call Settings

Setting	Description
Anonymous Call Reject	Select to block incoming calls that have no caller ID.
Enable Anonymous Call	Select to make outgoing calls that remove your own caller ID information.

Do Not Disturb Settings

Setting	Description
Enable DND	Turns Do Not Disturb on or off.

Call Forward Settings

Setting	Description
Enable Call Forward Always	Select to enable call forwarding for all calls on that account.
Target Number	Enter a number to which all calls will be forwarded.
Enable Call Forward Busy	Select to enable call forwarding for calls when you are on another call on that account.
Target Number	Enter a number to which calls will be forwarded when the line is busy.
Enable Call Forward No Answer	Select to enable call forwarding for unanswered calls on that account.
Target Number	Enter a number to which unanswered calls will be forwarded.
Delay	Select the number of rings before unanswered calls are forwarded. Range: 1 to 10 rings Default: 6 rings

User Preferences

On the User Preferences page, you can configure the WebUI language. After changing the setting on this page, click **Save** to save.

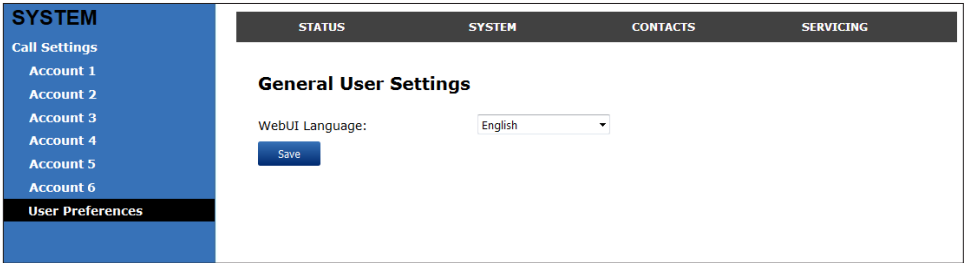

SYSTEM

Call Settings
Account 1
Account 2
Account 3
Account 4
Account 5
Account 6
User Preferences

STATUS SYSTEM CONTACTS SERVICING

General User Settings

WebUI Language:

Save

General User Settings

Setting	Description	Range	Default
WebUI Language	Sets the language that appears on the WebUI.	Any language supported by your phone. For example, English, French, Spanish, etc.	English

Base Directory

To view the base directory, click **CONTACTS** in the WebUI header, and then click **Base directory** in the sidebar.

On the Base directory page, you can manage your base directory entries. You can sort, edit, delete, and add contact information for up to 200 entries. The page also allows you to export your phone's base directory or import a base directory file. The export function lets you back up your contacts to your computer.

The Base directory lists entries across several pages. Click **Next**, **First**, **Last**, or a page number to view the desired page of entries.

Note: You can also use the phone menu to manage your base directory entries. For more information, see "Using the Directory" on page 30.

CONTACTS

Base Directory
Blacklist

STATUS SYSTEM CONTACTS SERVICING

Base Directory

Select All Sort By Last Name

Total: 21	First Name	Last Name	Ringer Tone	Work	Mobile	Other	Account	
<input type="checkbox"/>	Angela	Martin	0	7325550118			1	Edit
<input type="checkbox"/>	Bronwyn	McDonald	0	2325550140			1	Edit
<input type="checkbox"/>	Charlie	Johnson	0	5550198			1	Edit
<input type="checkbox"/>	Dale	Appleton	0		6045550135		1	Edit
<input type="checkbox"/>	David	Carter	3	2325550194	2325550177		2	Edit
<input type="checkbox"/>	David	Swerdlow	0		2325550172		1	Edit
<input type="checkbox"/>	Elkhart	Taxi	0		6045550155		1	Edit
<input type="checkbox"/>	Graham	Ball	0		2325550176		1	Edit
<input type="checkbox"/>	Kathryn	Dolphy	0		6045550195		1	Edit
<input type="checkbox"/>	Linda	Miller	0		6045550117		2	Edit
<input type="checkbox"/>	Lydia	Braithwaite	0	2325550157			1	Edit
<input type="checkbox"/>	Martin	Meyers	0	2325550122			1	Edit
<input type="checkbox"/>	Mary	Williams	0		6045550145	6045550146	1	Edit
<input type="checkbox"/>	Richard	Serling	0		6045550141	7875550181	2	Edit
<input type="checkbox"/>	Robert	Brown	2		6045550105		2	Edit
<input type="checkbox"/>	Sandro	Voss	0	2325550149			1	Edit
<input type="checkbox"/>	Stefan	Wheeler	0		2325550161		1	Edit
<input type="checkbox"/>	Susan	Ballance	0		6045550170		1	Edit
<input type="checkbox"/>	Terry	Ng	0		2325550187		1	Edit
<input type="checkbox"/>	Ursula	Baldwin	0	6045550166			1	Edit

First 1 Last Next

Delete Selected Entries Add New Entry Clear Directory

Import Base Directory

No File Chosen Choose File

Import

Export Base Directory

Export

Base directory

Click	To...
Sort By Last Name	Sort the list by last name.
Edit	Edit information for an entry.
Last	View the last page of entries.
Next	View the next page of entries.
Delete Selected Entries	Delete selected entries from the directory. Click Select All to select every entry on the page you are viewing.
Add New Entry	Add a new directory entry.
Clear Directory	Delete all Directory entries

To add a new directory entry:

1. Click **Add New Entry**.

The **Create Base directory Entry** page appears.

2. Enter the required information. At minimum, a first and last name are required.

Setting	Description	Range	Default
First Name	Enter the appropriate names in these fields.	n/a	n/a
Last Name			
Ringer Tone	Sets a unique ringer tone for calls from this directory entry.	Auto, Tone 1–10	Auto
Account	Sets the account used when you dial this directory entry.	Default Account, Account 1–Account 6	Default Account
Work Number	Enter the appropriate numbers in these fields.	n/a	n/a
Mobile Number			
Other Number			

3. Click **Save**.

To edit a directory entry:

1. Click **Edit** for the entry you want to edit.

The **Edit Base directory Entry** page appears.

CONTACTS	STATUS	SYSTEM	CONTACTS	SERVICING
Base Directory Blacklist	Edit Base Directory Entry			
First Name:	<input type="text" value="John"/>			
Last Name:	<input type="text" value="Smith"/>			
Ringer Tone:	<input type="text" value="Auto"/>			
Account:	<input type="text" value="Default Account"/>			
Work Number:	<input type="text" value="5551231234"/>			
Mobile Number:	<input type="text" value="5558729663"/>			
Other Number:	<input type="text" value="5556126549"/>			
<input type="button" value="Save"/>				

2. Edit or add the desired information.
3. Click **Save**.

Import Base directory

You can import an existing base directory file. Importing a directory file replaces all your previous base directory entries. After importing a directory file, you can add, edit, or delete entries as desired.

Note: Directory files are .xml files containing contacts and contact information. For more information about creating or editing a directory file, consult your system administrator.

To import a base directory file:

1. Click **Choose File**.
2. In the **Choose File to Upload** window, navigate to the directory file.
3. Click the file, and then click **Open**.
4. On the WebUI, click **Import**.

Export Base directory

You can export the directory and save it as an .xml file on your computer.

To export the base directory:

1. Click **Export**.
2. At your browser's prompt, save the file to the desired location on your computer.

Blacklist

To view the Blacklist, click **CONTACTS** in the WebUI header, and then click **Blacklist** in the sidebar.

The Blacklist directory is identical to the Base directory, except that you cannot configure an incoming ringer tone.

Security

On the Security page, you can change the User Password that you use to access the WebUI.

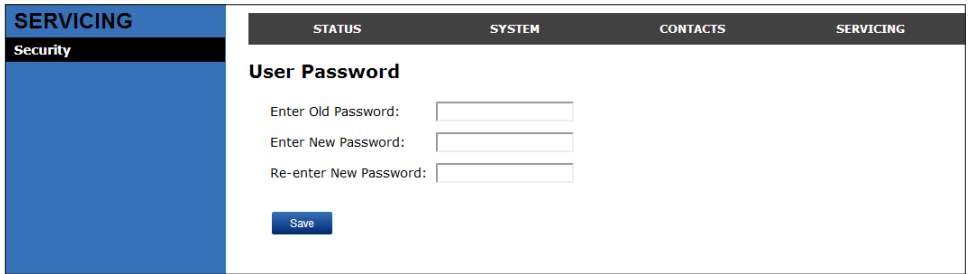

The screenshot shows a web interface with a blue sidebar on the left containing the text "SERVICING" and "Security". The main content area has a dark header with tabs for "STATUS", "SYSTEM", "CONTACTS", and "SERVICING". Below the header, the "User Password" section contains three input fields: "Enter Old Password:", "Enter New Password:", and "Re-enter New Password:". A blue "Save" button is located below the input fields.

After changing your password, click **Save**.

Troubleshooting

If you have difficulty with your handset, please try the suggestions below. For customer service, visit our website at businessphones.vtech.com or call **1 (888) 370-2006**.

General issues

Handset does not work at all (LCD is black)

- Confirm the battery is installed and charged correctly.
- Place the handset into its charger. Ensure the charger is securely plugged into an outlet not controlled by a wall switch.
- If the battery is completely depleted, it can take up to 10 minutes to charge the battery before the low battery icon displays on screen.

My caller ID isn't working.

- Caller ID is a subscription service. Your telephone service provider may require subscription to this service for this feature to work.
- The caller must be calling from an area that supports caller ID.
- Both your telephone service provider and your caller's service provider must use caller ID compatible equipment.

Handset registration is not working

- Place the handset in the charger for a few seconds, remove it and repeat the registration procedure.
- Ensure the handset is within range of the base station.

Cannot make external calls

- Check if your SIP account is registered (Press **MENU** → **Status** → **Line** and select a line. Check that the status reads **Registered**).
- You might be out of range of the base station. Try moving closer. If you see an idle screen with no alerts, then your handset is successfully communicating with the base station.

Handset does not receive incoming calls

- Ensure that **Do Not Disturb** and **Call Forward All** are turned off.
- Check if your SIP account is registered (Press **MENU** → **Status** → **Line** and select a line. Check that the status reads **Registered**).
- You might be out of range of the base station. Try moving closer.

Cannot locate handset using base station

- The handset may not be registered.
- If the handset battery is dead or the handset is out of range, the locator tone will not sound.

Poor audio quality. Speech is cutting out.

- You may be close to being out of range of the base station. Try moving closer.
- Other electronic products can cause interference with your handset. Try installing the base station far away from devices such as TVs, microwaves, or other cordless devices, including other handsets.
- If the problem persists, contact your system administrator.

Technical Specifications

RF frequency band	1921.536–1928.448 MHz
Channels	5
Operating temperature	32–122 °F (0–50 °C)
Power requirements	Base: 5.0 Vdc @ 1000 mA Handset charger: 6.0 Vdc @ 400 mA Handset: 2.4 V 550/750 mAh, Ni-MH battery pack
Power over Ethernet	IEEE 802.3at supported, class 2
Ethernet network port	10/100 Mbps RJ-45 port

Special characters

Entering special characters

When entering text using the dial pad, the following special characters are available. Press the 1, 0, or pound sign (#) keys to enter special characters.

Key	Characters
1	~ ^ ` % ! & - _ + =
0	0 : ; , ? . @ *
#	() [] { } < > / \ #

Press star (✱) to switch between uppercase and lowercase/European characters.

Maintenance

Taking care of your telephone

- Your base station and cordless handset contain sophisticated electronic parts, so you must treat them with care.
- Avoid rough treatment.
- Place the handset down gently.
- Save the original packing materials to protect your products if you ever need to ship them.

Avoid water

- You can damage your cordless telephone if it gets wet. Do not use the handset in the rain, or handle it with wet hands. Do not install the base station and handset near a sink, bathtub or shower.

Electrical storms

- Electrical storms can sometimes cause power surges harmful to electronic equipment. For your own safety, take caution when using electric appliances during storms.

Cleaning your telephone

- Your products have a durable plastic casing that should retain its luster for many years. Clean it only with a soft cloth slightly dampened with water or a mild soap.
- Do not use excess water or cleaning solvents of any kind.

Remember that electrical appliances can cause serious injury if used when you are wet or standing in water. If the telephone base should fall into water, **DO NOT RETRIEVE IT UNTIL YOU UNPLUG THE POWER CORD FROM THE WALL**, then pull the unit out by the unplugged cord.

Deregistering the handset

Before using the handset with a different base station, you must deregister the handset from the base station to which it is currently registered.

GPL License Information

GPL code requests

Portions of the software associated with this product are open source, and fall within the scope of the GNU General Public License (GPL). Accordingly, those portions of code are available to the public, consistent with the requirements of the GPL, in either source code format or object code format, depending upon the nature of the code at issue. If you would like to exercise your right to receive the available code, please send a written request for the available code along with a cashier's check, payable to VTech Communications, Inc., in the amount of \$15.00 (U.S.\$) to:

VTech Communications, Inc.,
9590 SW Gemini Drive, Suite 120
Beaverton OR 97008

ATTN: Information Technology Group—VSP600 GPL code request

If your request does not fully comply with the foregoing requirements, VTech reserves the right to reject your request. Further, by requesting and receiving the available code, you release VTech, its affiliates, and its and their officers, directors, employees, and representatives ("VTech Parties") from any liability or responsibility relating to such code, and you acknowledge that the VTech Parties make no representations with respect to the origin, accuracy, usability, or usefulness of such code, and the VTech Parties have no responsibility to you whatsoever concerning the code, including without limitation any responsibility to provide explanation, support, upgrade, or any communication whatsoever. Your review or use of the available code is at your sole risk and responsibility.

VTECH COMMUNICATIONS LTD.

A member of THE VTECH GROUP OF COMPANIES.

Distributed in the U.S.A. by VTech Communications Inc., Beaverton, Oregon 97008.

VTech is a registered trademark of VTech Holdings Limited.

ErisTerminal® is a registered trademark of VTech Communications Inc.

Specifications are subject to change without notice.

Copyright © 2015–16 for VTECH COMMUNICATIONS LTD. All rights reserved.

Version 7, 06/16